



CHINT 正泰

让电尽其所能

CHINT Power PV Inverter for EU Market

2023 New EU Version

智慧能源解决方案提供商



CHINT – Empower the world

- 1. CHINT Overview**
2. Residential PV Inverter
3. Commercial & Utility PV Inverter
4. Residential Hybrid Storage Inverter
5. Reference

CHINT – Empower the world

CHINT Founded in 1984



Build the whole ReEnergy industrial chain, the leading brand of electrical & Green energy Industrial.

601877

CSI 300
MSCI

Revenue 2022

16.9 Billion
Dollar

Forbes Asia Top

50 Companies

Business across over

140 Countries



Employees

> **30000**

CPS – Shanghai CHINT Power Systems CO., Ltd.

CHINT

正泰电源

Light up the world by ReEnergy!



Company Name:

Shanghai Chint Power Systems Co., Ltd.

Founded:

2009

Head Quarter:

Shanghai China



Scope of Business :

Research and development, manufacturing and sales,

- ◆ On-grid & Hybrid inverter
- ◆ ITS, ESS station
- ◆ Battery, Energy Storage System

Manufacturing and Capacity

CHNT

正泰电源

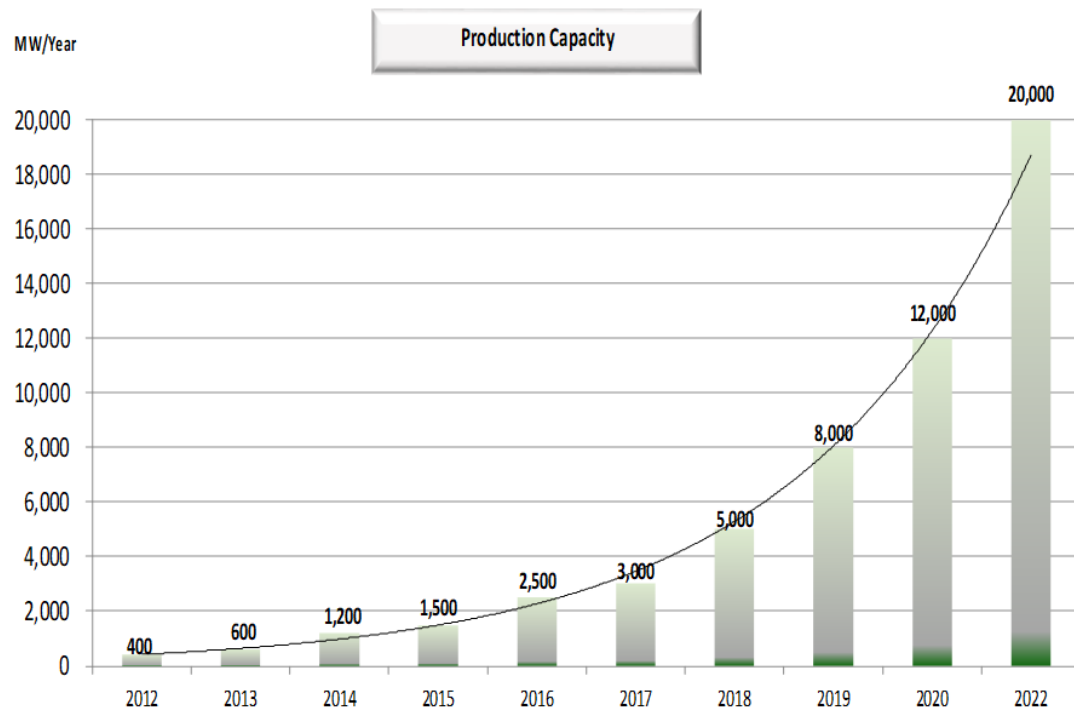

CHINT PV Inverter Portfolio For EU Market

Single Phase String Inverter



2 / 3 / 3.6 / 4.6 / 5 / 6 kW

Three Phase String Inverter



5 / 6 / 8 / 10 / 15 / 20 / 25kW



30kW



50/60kW



110/120/125kW 1100Vdc



275kW 1500Vdc

Chint Power ESS Residential Solution

CHINT

正泰电源

Residential ESS

Hybrid Inverter



Single phase hybrid inverter
CPS SCE4.6KTL-120/EU
CPS SCE5KTL-120/EU
CPS SCE6KTL-120/EU

Three phase hybrid inverter
CPS SCE5KTL-T/EU
CPS SCE6KTL-T/EU
CPS SCE8KTL-T/EU
CPS SCE10KTL-T/EU



BL051100-A1 (5kWh)
BL051200-A1 (10kWh)

Battery



LV series battery
CPS ESSR-05KL1
CPS ESSR-10KL1
CPS ESSR-15KL1
CPS ESSR-20KL1

HV series battery
CPS ESSR-05KH1
CPS ESSR-10KH1
CPS ESSR-15KH1
CPS ESSR-20KH1

Certification and Quality System

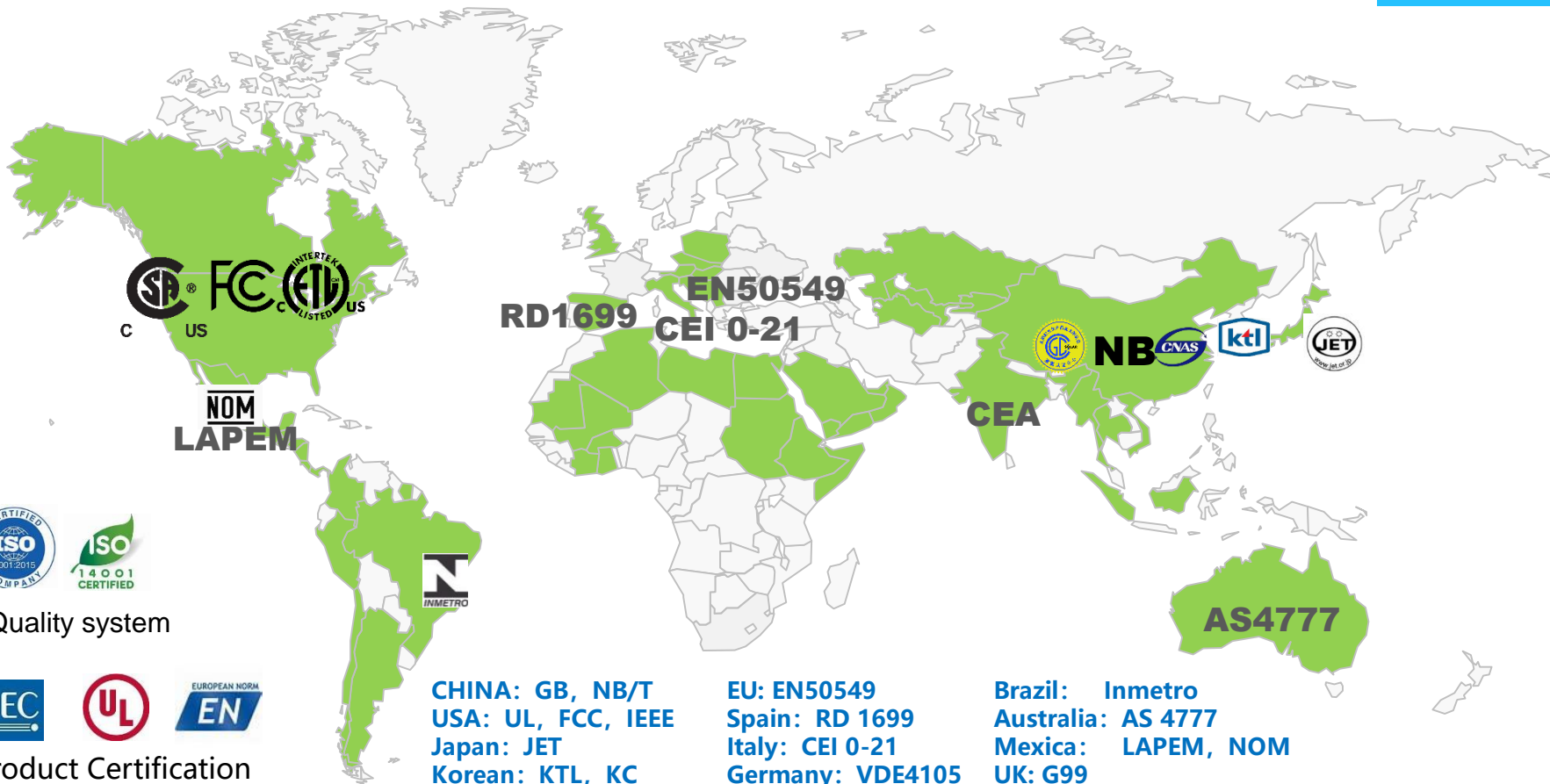

Bankability in 2022 from Bloomberg NEF

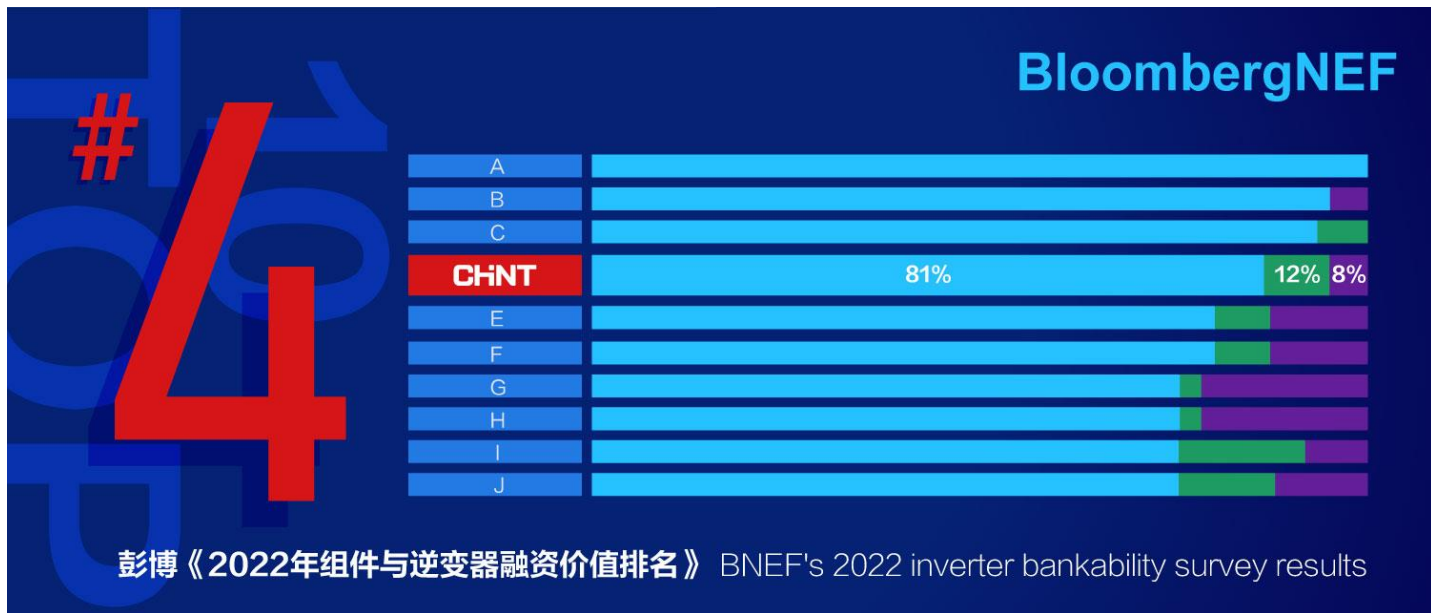

CHINT Power System ranks NO. 4 in Global Bloomberg Bankability

Chint Power Inverter Market Share

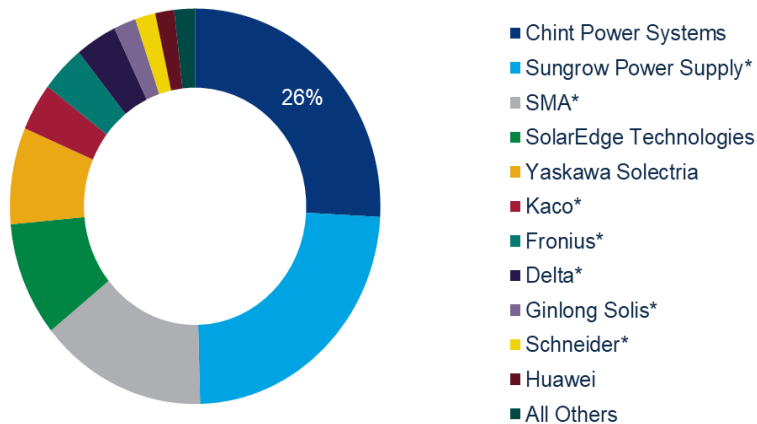

NO.1 market share, C&I 3phase string inverter in American market

Source: Wood Mackenzie (GTM)

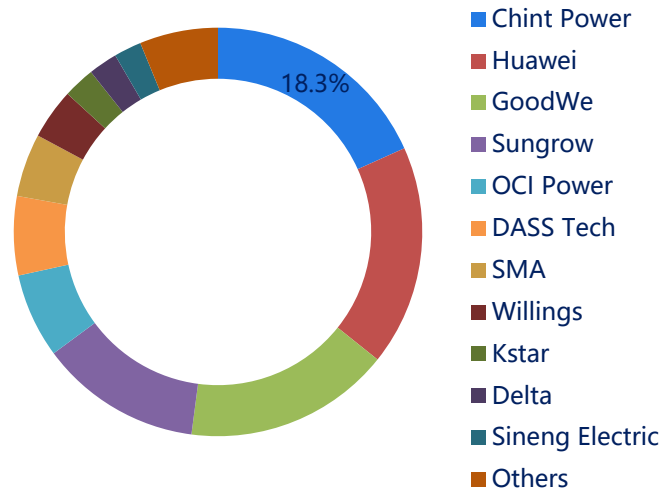

No.1 market share in South Korea

Source: IHS

B

CHINT – Empower the world

1. CHINT Overview
- 2. Residential PV Inverter**
3. Commercial & Utility PV Inverter
4. Residential Hybrid Storage Inverter
5. Reference

Residential 2-25kW Inverter PV adaptability

CHNT

正泰电源

2-3.6kW
1 MPPT



CPS SCA 2KTL-PS1
CPS SCA 3KTL-PS1
CPS SCA 3.6KTL-PS1

4.6-6kW
2 MPPT



CPS SCA 4.6KTL-PSM1
CPS SCA 5KTL-PSM1
CPS SCA 6KTL-PSM1

- Max. Input PV Current: 15A
- DC/AC Overload: 150%
- Protection: SPD (AC type2,DC type2)
- Local commissioning: Built in Bluetooth
- Cooling: Natural cooling
- IP65 waterproof and dustproof, C5 anti-corrosion

5-25kW **2 MPPT**



CPS SCA5KTL-T1
CPS SCA6KTL-T1
CPS SCA8KTL-T1
CPS SCA10KTL-T1
CPS SCA15KTL-T1
CPS SCA20KTL-T1
CPS SCA25KTL-T1

Single phase inverter external (-PS1/PSM1 Series)

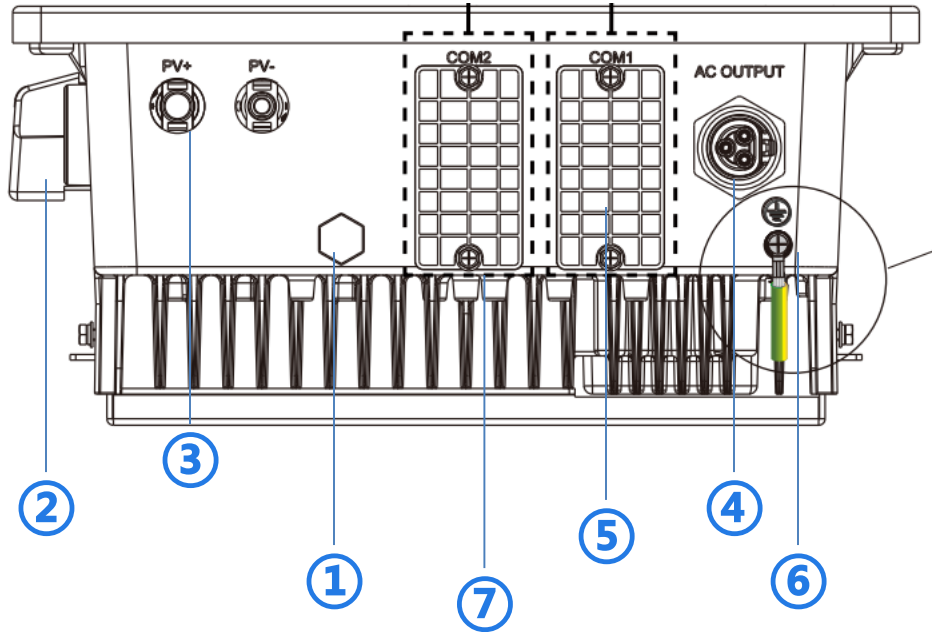

1. Vent valve
2. DC isolation breaker
3. PV Strings connector
4. AC output connector
5. Communications interface
6. External Protection Ground interface
7. CT/RS485

Three phase inverter external 5-25-T1

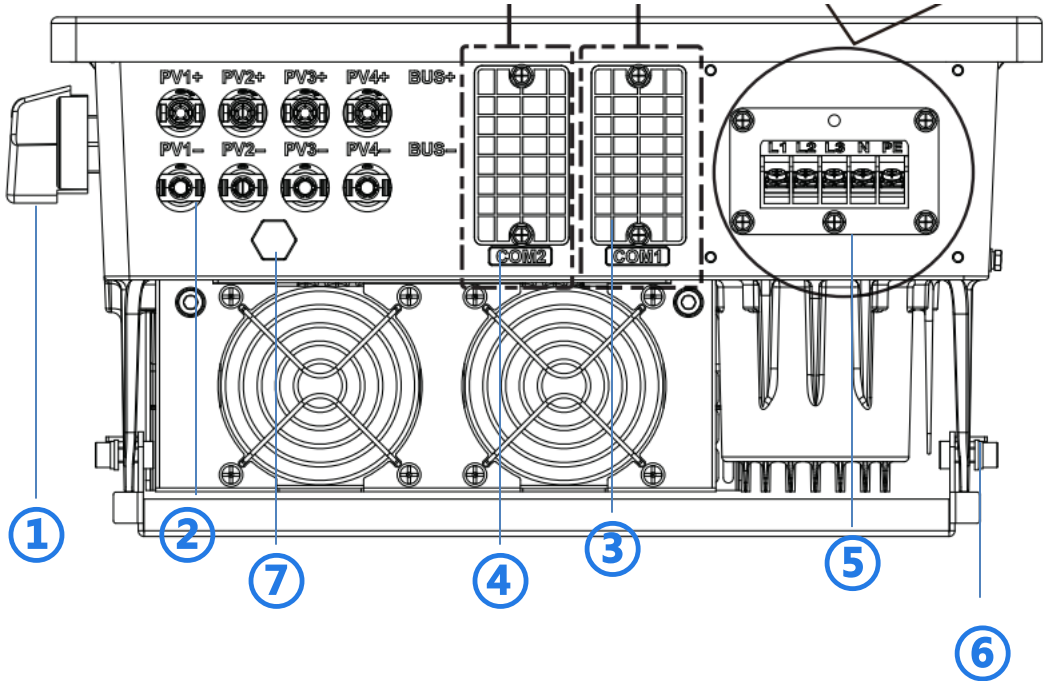

- 1. DC isolation breaker
- 2. PV strings connectors
- 3. Communication interface
- 4. RS485
- 5. AC output connectors
- 6. External Protection Ground interface
- 7. Vent valve

Monitor——Quick module

CHNT

正泰电源

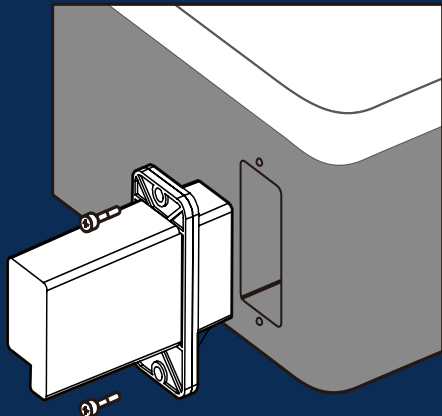

WiFi Module, 4G optional



Support **off line data store** 5 days



Easy plug-in connection with the inverter for easy installation



Flexible configuration, optional **4G module**



Data storage throughout the PV life cycle



APP or Web can monitor data



Remote parameter setting and software upgrade



CHINT – Empower the world

1. CHINT Overview
2. Residential PV Inverter
- 3. Commercial & Utility PV Inverter**
4. Residential Hybrid Storage Inverter
5. Reference

30kW Inverter PV adaptability

CHNT

正泰电源

30kW 2 MPPT



CPS SCA30KTL-T1

- DC1000V
- Max. Input PV Current: 13A
- DC/AC Overload: 150%
- Local commissioning: Built in Bluetooth
- Cooling: Cooling fans
- Non LCD Design (Wifi+APP)
- IP65 waterproof and dustproof, C5 anti-corrosion

50/60/110/120 kW String inverter PV adaptability

CHNT

正泰电源

50/60kW-1100Vdc-400Vac-4MPPT



- Maximum efficiency: 99.0%
- Protection: SPD (AC type2, DC type2)
- DC/AC ratio can be achieved 1.5;
- Support LVRT and HVRT
- Local commissioning: Built in Bluetooth
- Non LCD Design (Wifi+APP)
- Cooling: Smart Fan cooling

110kW-1100Vdc-400Vac-9MPPT
120kW-1100Vdc-400Vac-12MPPT

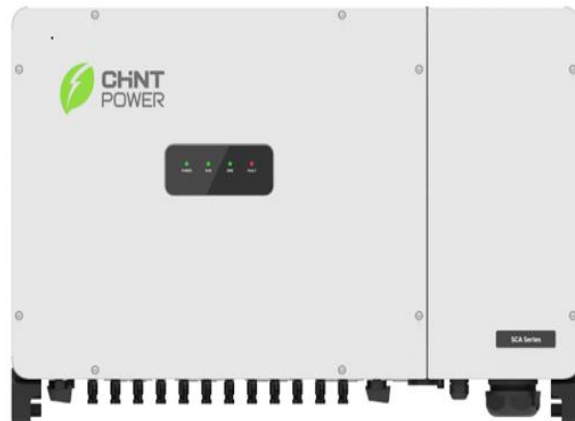

275kW String inverter

CHNT

正泰电源



275kW-1500Vdc-800Vac-12MPPT

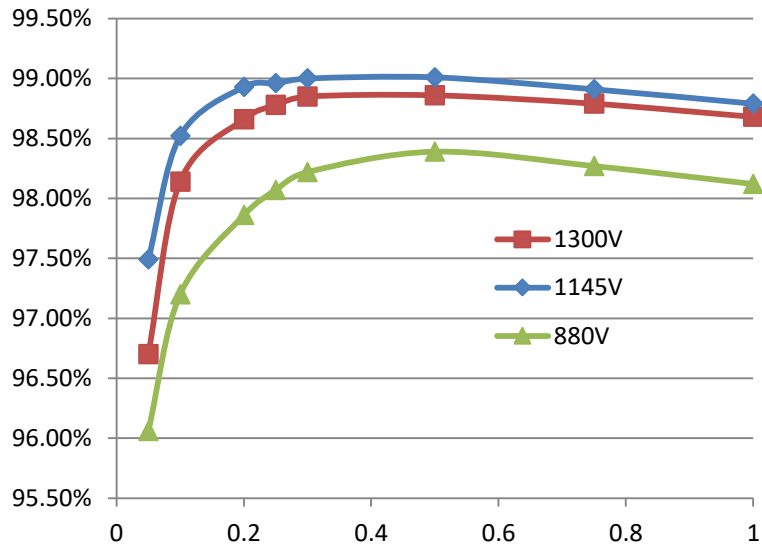

String monitor

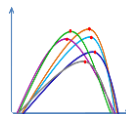

12 MPPT



IP66&C5



Class 2 SPD



Max efficiency 99.01%

Better temperature performance

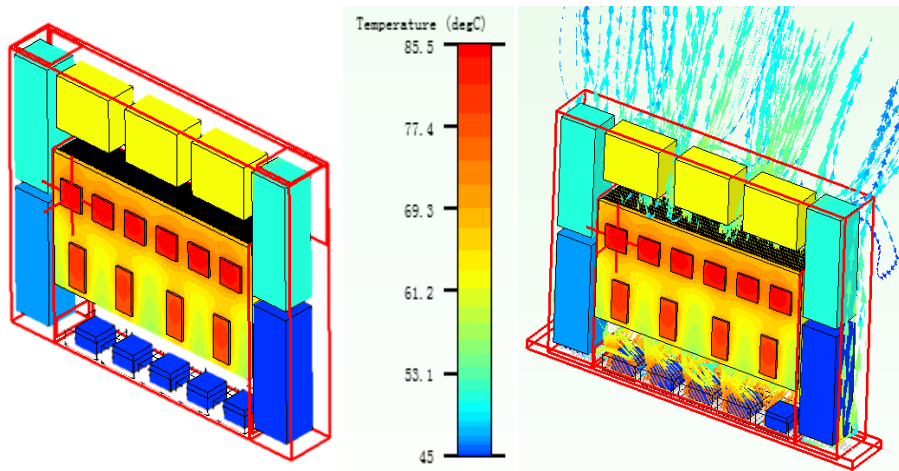

INVERT L1-1 (degC)	INVERT L1-2 (degC)	INVERT L2-1 (degC)	INVERT L2-2 (degC)	INVERT L3-1 (degC)	INVERT L3-2 (degC)	BOOST B1 (degC)	BOOST B2 (degC)	BOOST B3 (degC)	BOOST B4 (degC)
85.5109	85.1117	84.8578	85.1284	84.9174	85.0216	79.9602	79.4276	79.2749	79.4585

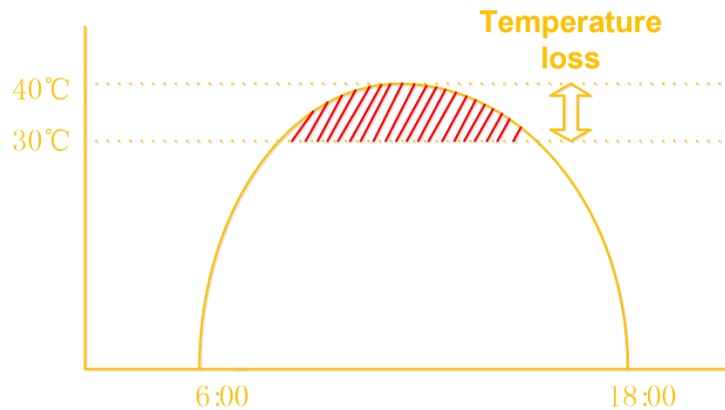
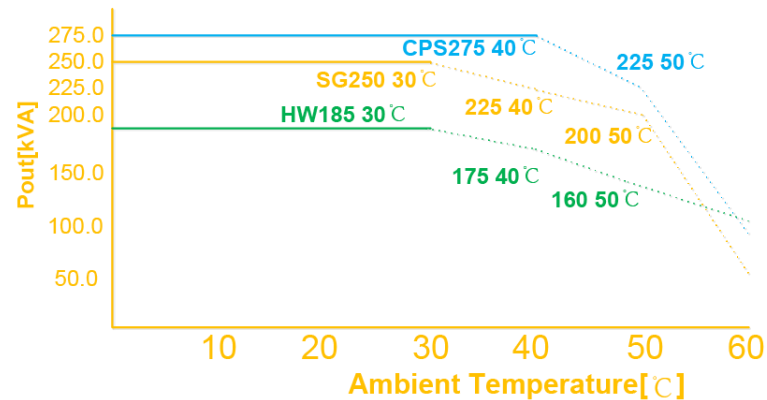

D

CHINT – Empower the world

1. CHINT Overview
2. Residential PV Inverter
3. Commercial & Utility PV Inverter
- 4. Residential Hybrid Storage Inverter**
5. Reference

Residential Hybrid Storage Inverter 4.6-10kW

CHNT

正泰电源



Certificate:

EU EN50549-1

German VDE 4105

UK: G99 Italy: CEI 0-21

Spain: UNE217001,217002, NTS TypeA

IEC: IEC61727 / IEC62116

Safety: IEC62109-1/2, IEC 62477, IEC62040-1

EMC: IEC/EN61000-6-1/2/3/4



Max. efficiency(PV to grid): 97.3%
Max. efficiency(Charge/Discharge): 94.0%



Max.PV current 2*15A, Compatible with (500W+) modules
Max.Charge/Discharge Current 120A



Remote configuration and upgrade



APP Quick commissioning



Multiple protection :SPD/GFCI(optional) etc.

Residential Storage Hybrid Inverter External Interfaces

CHNT

正泰电源

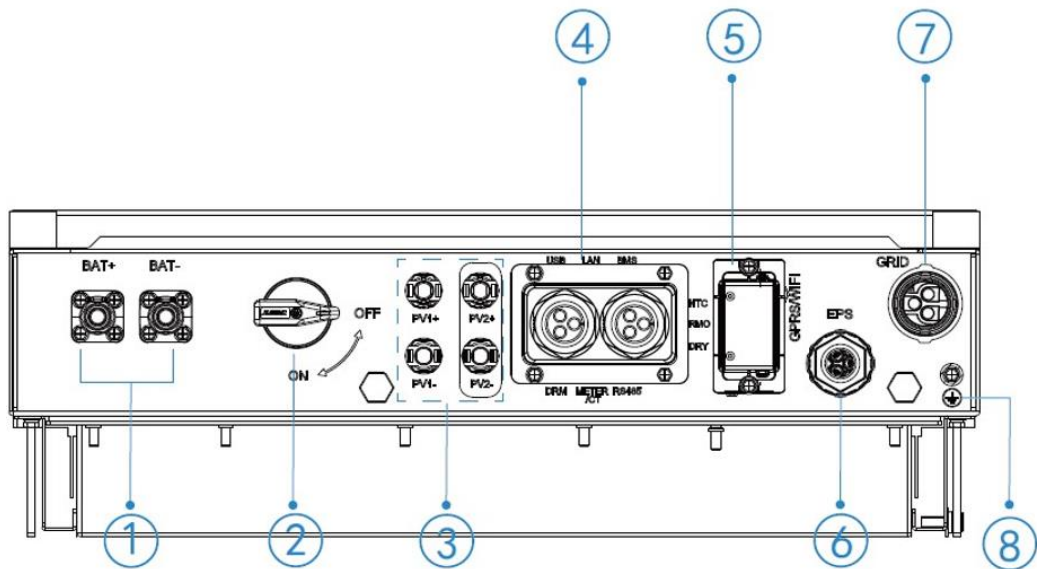

1. Battery Connect Interface
2. DC Switch
3. PV Input Interface
4. Communications Interface
5. GPRS/WiFi Interface
6. EPS Output Connectors
7. GRID Output Connectors
8. External Protection Grounding

Hybrid ESS system

CHNT

正泰电源

- Self use mode
- Feed-in Priority Mode
- Time-Based Control Mode
- Back-up Mode

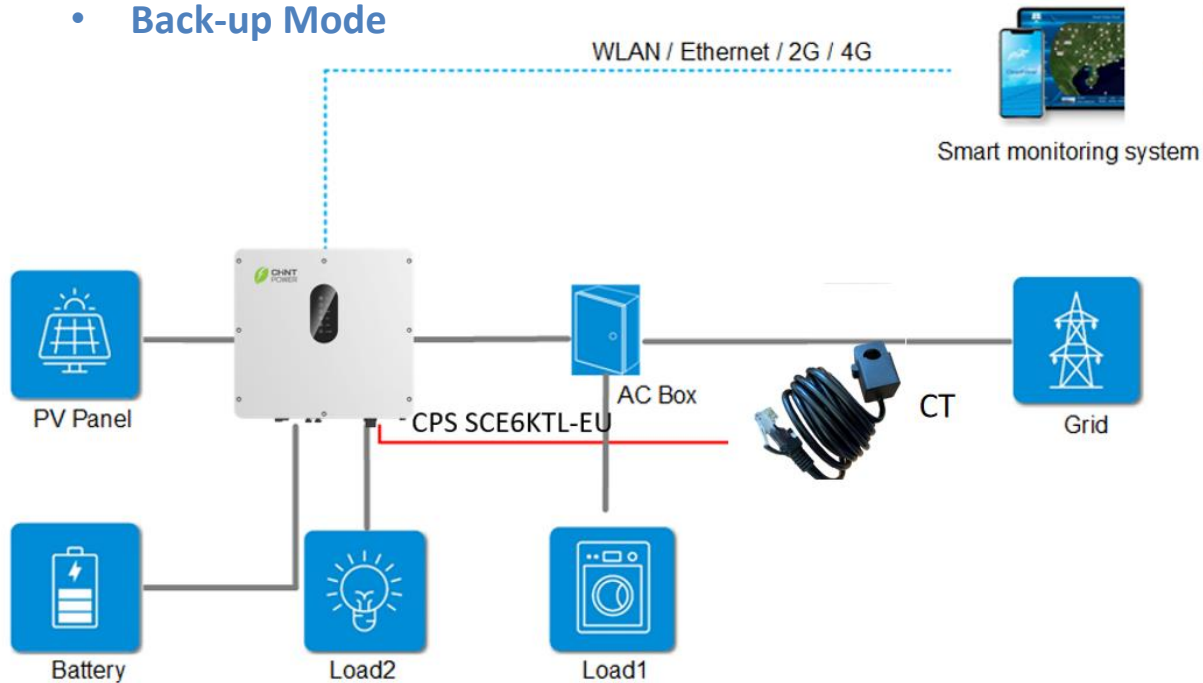

AC Coupled Inverter

- Lithium Battery



Communication Accessory

- WiFi/4G Optional



Current sensor 300A

- 3m cable



Smart Solar Cloud

- Android/iOS APP & WEB

Residential ESS BL051100-A1/BL051200-A1

CHNT

正泰电源



Certification:

IEC62040, IEC62619
IEC61000, UN38.3

- LiFePO4 cells from CATL
 - Highest-quality LiFePO4 cells
 - Powered by the market leader
- Everything included
 - Power cables and communication cable connected to the inverter
 - Manual, warranty card and power terminal covers for transport safety
- IP65 Protection
 - Adapt to more severe environmental requirements
- Longer life, more returns
 - 70%EOL with 10 years warranty

CPS ESSR 5~20kWh Series

CHNT

正泰电源



- IP65 protection, ultra-thin design, saving installation space.
- Floor Mount & Wall Mount, plug-in installation, no wiring between Packs.
- Automatic allocation of master address and slave address, simple operation.
- Modular design, flexible configuration and capacity expansion, supporting the mixing of new and old batteries.
- Long life, 70%EOL with 10 years warranty.
- Support Mobile APP, easy management.



CHINT – Empower the world

1. CHINT Overview
2. Residential PV Inverter
3. Commercial & Utility PV Inverter
4. Residential Hybrid Storage Inverter
- 5. Reference**

Excellent Performance in North America



National Market Share Est.* - Annual				
	2015	2016	2017	2018 YTD
SMA	33.4%	30.5%	25.0%	20.9%
Solectria/Yaskawa	19.9%	30.9%	23.5%	15.8%
SolarEdge Technologies	4.7%	7.3%	11.0%	15.6%
Chint Power Systems	3.7%	5.8%	9.3%	13.8%
Sungrow	1.3%	3.5%	9.4%	9.4%
Huawei	0.0%	0.9%	3.4%	7.8%

CPS Shipment : 6+GW

CPS Projects : 12000+

Inverter Qty: > 160 Thousands Pcs.

Customer base: 180+ active customers.

NO.1 market share, 2015~2020 C&I 3p string inverter in American market

Ref. Project – Residential Projects



Italy MARCHE Project

Site : SAN BENEDETTO DEL TRONTO (AP)

Size : 6,82 kWp

Product: 4 x SCA1KTL-S/EU
1 x SCA2KTL-S/EU

Ref. Project – Residential Projects



Italy MARCHE Project

Site : ASCOLI PICENO (AP)

Size : 3 kWp

Product: SCA3KTL-S/EU

Ref. Project – Complex Terrain

Zhangjiakou Olympic Corridor Project

Site : Zhangjiakou City, HeBei **Scale** : 875MW (270MW is operated)

Detail: **Detail:** 60kW inverter and 500kW central

Project terrain undulating mountains, valleys. Elevation in the range of 1000 to 2000 meters. With the 2022 Zhangjiakou City Winter Olympics as the entry point boutique project," Governance haze, Bid, ecology, Green energy, Benefit the people "as the theme. The project is 85 kilometers long, with 42,000 mu of ecologically fragile land being restored and 10 abandoned quarrying mines renovated, benefiting tens of thousands of farmers.



Ref. Project – Low temperature & Complex Terrain

Low temperature and Complex Terrain



Keshan Poverty alleviation Project

Site : Keshan Town, Heilongjiang

Size : 6.3MW

Inverter: CPS SCA50KTL-DO

Temperature : -37°C ~ + 37 °C



Xuanhua PV Project

Site : Xuanhua, Hebei

Size : 60MW

Product: CPS SCA60KTL-DO
CPS SCA500KTL-H



Ref. Project – Large-Scale Field station

CHNT 正泰

让电尽其所能



Mexico PV Power Station

Location: Mexico City, Mexico

Scale: 20MW

Inverter: CPS SCA25KT

Commissioned: 2015



Ref. Project – Large-Scale Roof station

CHNT 正泰

让电尽其所能



Shanxi Binxian 20MW Rooftop PV Project

(Poverty Alleviation Project)

Location : binxian, Shanxi, China

Scale: 24.4MW

Product: CPS SCA36KTL-DO, SCA60KTL-DO

Power generation: > 40 million kWh/year



Ref. Project – Large-Scale Roof station



Los Angeles PV Project

Location: Los Angeles, USA

Scale: 2MW

Inverter: CPS SCA60KT-DO-UL-480

Commissioned: 2018



Ref. Project – Large-Scale Roof station



Huayu Lanterns Rooftop PV Project

Location : Danyang, Jiangsu, China

Scale: 2.7MW

Product: CPS SCA50KTL-DO
CPS SCA25KTL-DO, CPS SCA30KTL-DO



Deqing Industry Rooftop PV Project 2017

Location : Deqing, Zhejiang

Scale : 2.33MW

Product: 1MW PV Power Container
18*CPS SCA25KTL-DO
2*CPS SCA30KTL-DO



Ref. Project – Other PV station

CHNT 正泰

让电尽其所能



California 1500V Project

Location: California, USA

Inverter : CPS SCH125KT-DO-US-600

Commissioned: 2018



Ref. Project – Other PV station



Thailand MLT Factory Project

Location : MLT Factory, Thailand

Scale: 1MW

Product: CPS SCA30KTL-DO



Ref. Project – Other PV station



Location : Malaysia
Scale: 176kW
Inverter: CPS SC20KTL-DO
Commissioned: Mar , 2012



Location : Holland
Scale: 10MW
Inverter: CPS SC1.5KTL/ CPS SC2.8KTL
Commissioned: 2011-2012



Location : Belgium
Scale: 1.7MW
Inverter: CPS SC20KTL-DO
Commissioned: Oct , 2012



110kW inverter reference

CHNT

正泰电源



Zhejiang wenzhou
110kW 7 pcs
CPS SCA110KTL-DO
2021.3



Zhejiang wenzhou
110kW 2 pcs
CPS SCA110KTL-DO
2021.3

275kW inverter reference

CHNT

正泰电源

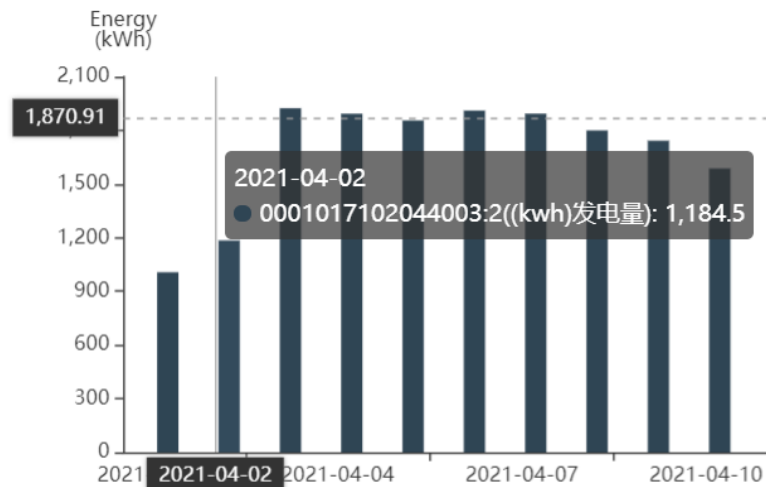
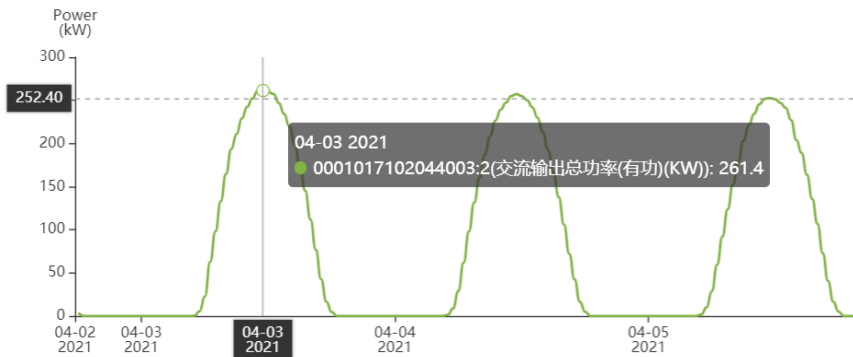

jilin 2MW

Size : 2MW

inverter : 8 Pcs. * CPS SCH250KTL-DO



Slovenia 8MW PV Project
Model: CPS SCH275KTL-DO
Quantity: 28 Units

275kW inverter reference



THANKS

2023